

Engineering the Intelligent Business Ecosystem

The Zyptex 2026 Operational Blueprint & Strategic Playbook.

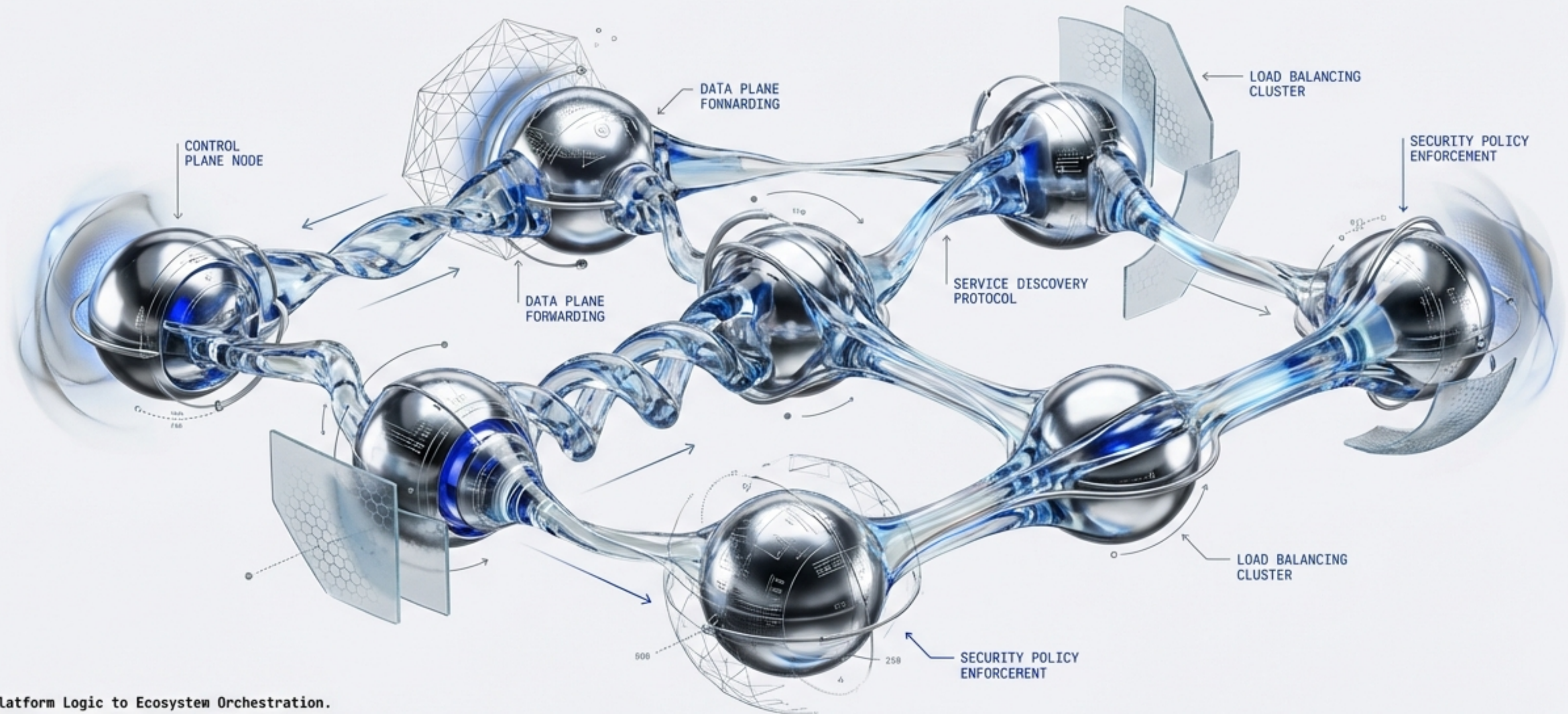

From Platform Logic to Ecosystem Orchestration.
Zyptex | Strategic Architecture of Excellence | Karachi • Global Kode

The Shift: From Platforms to Dynamic Ecosystems

The Platform Era (2000-2025)

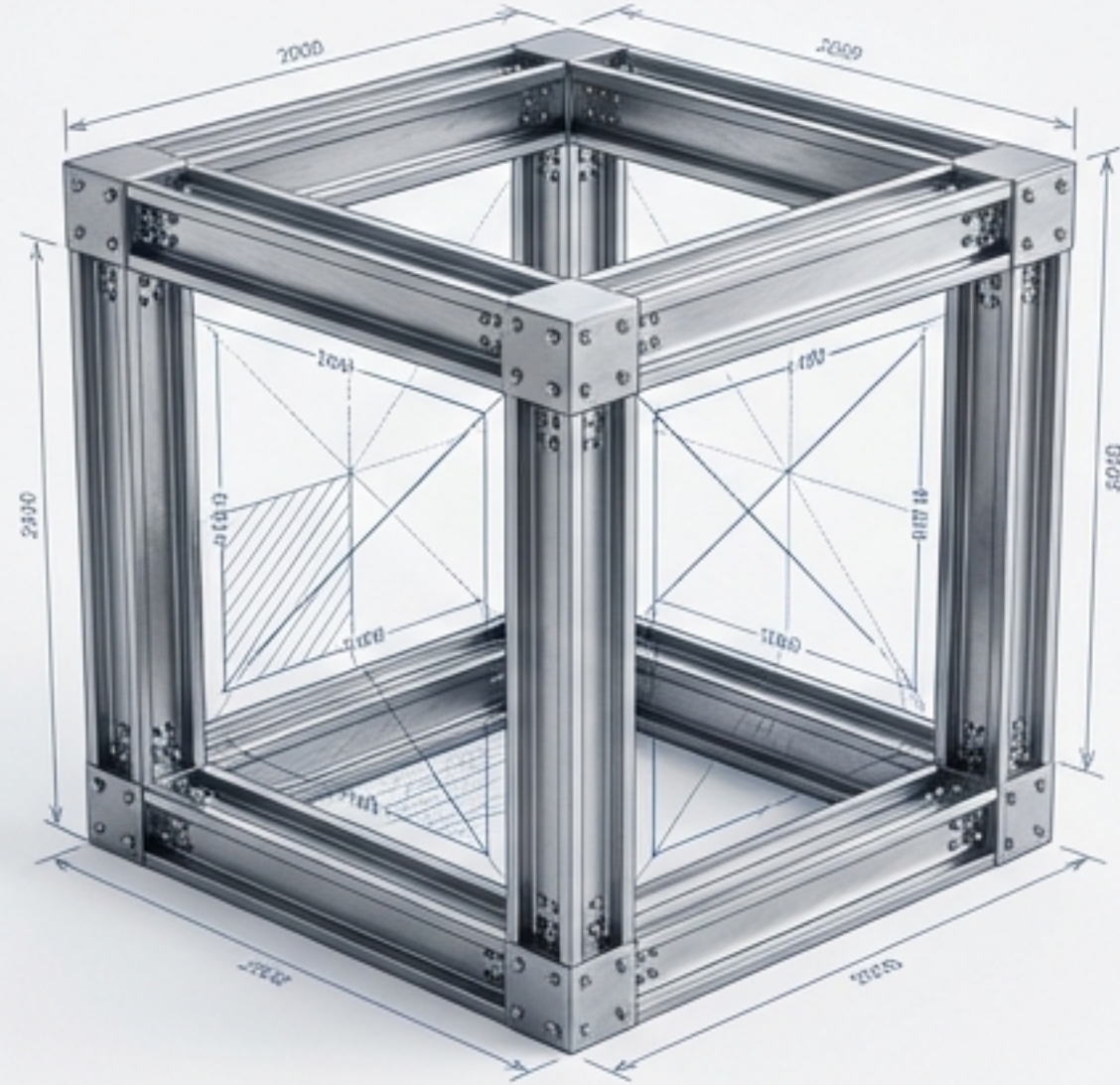

- ◆ Logic: Transaction-centric & Control-heavy
- ◆ Constraint: Centralized data lock-in
- ◆ Outcome: The Platform Plateau

The IIBE Era (2026-2030)

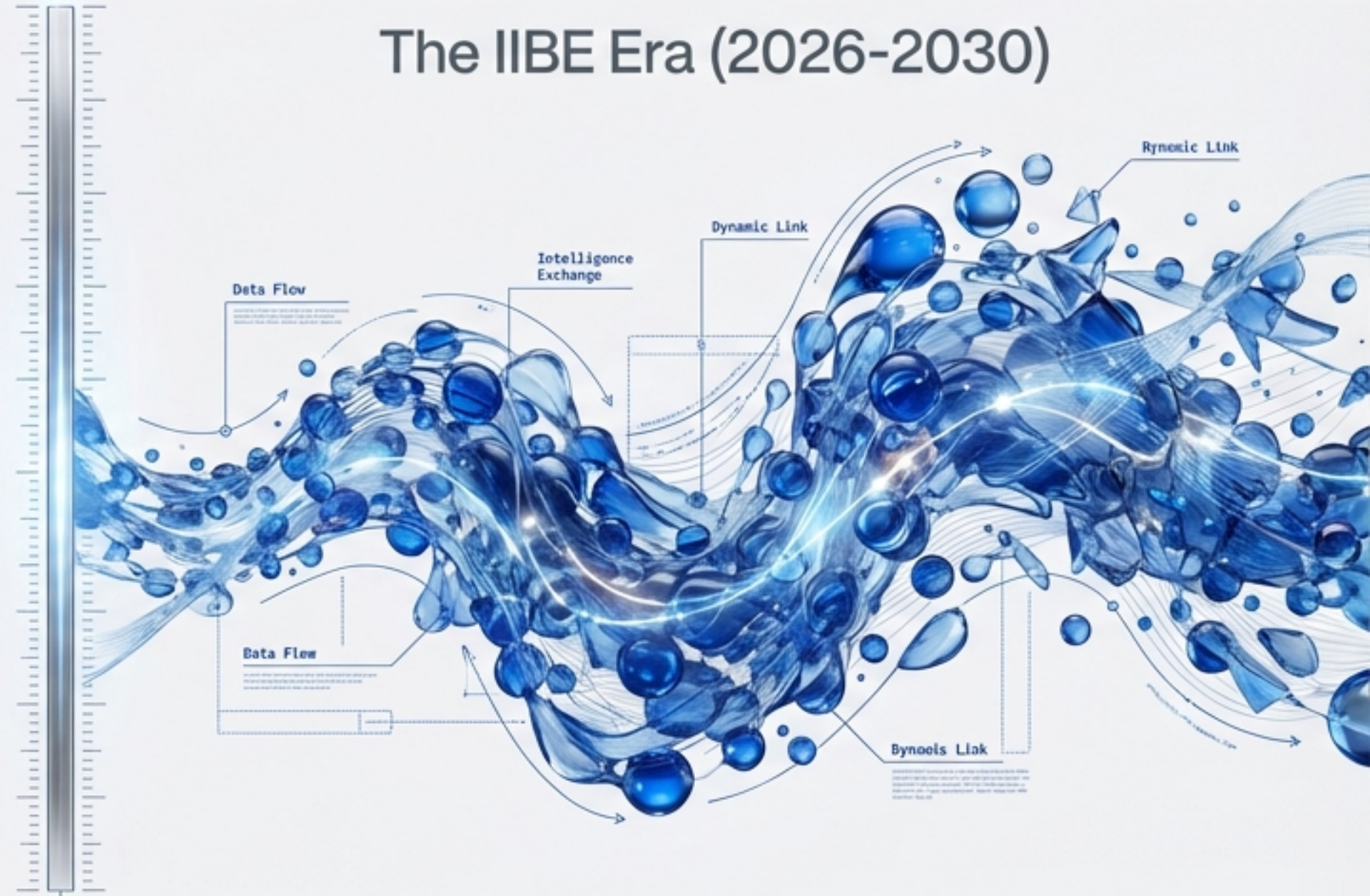

**Orchestration replaces Control.
Intelligence replaces Data Pipelines.**

- ◆ Logic: Orchestration & Shared Value
- ◆ Driver: Circulating Intelligence
- ◆ Outcome: Integrated Interconnected Business Ecosystem (IIBE)

The New Intelligence Fabric



Strategic vs. Tactical Programming

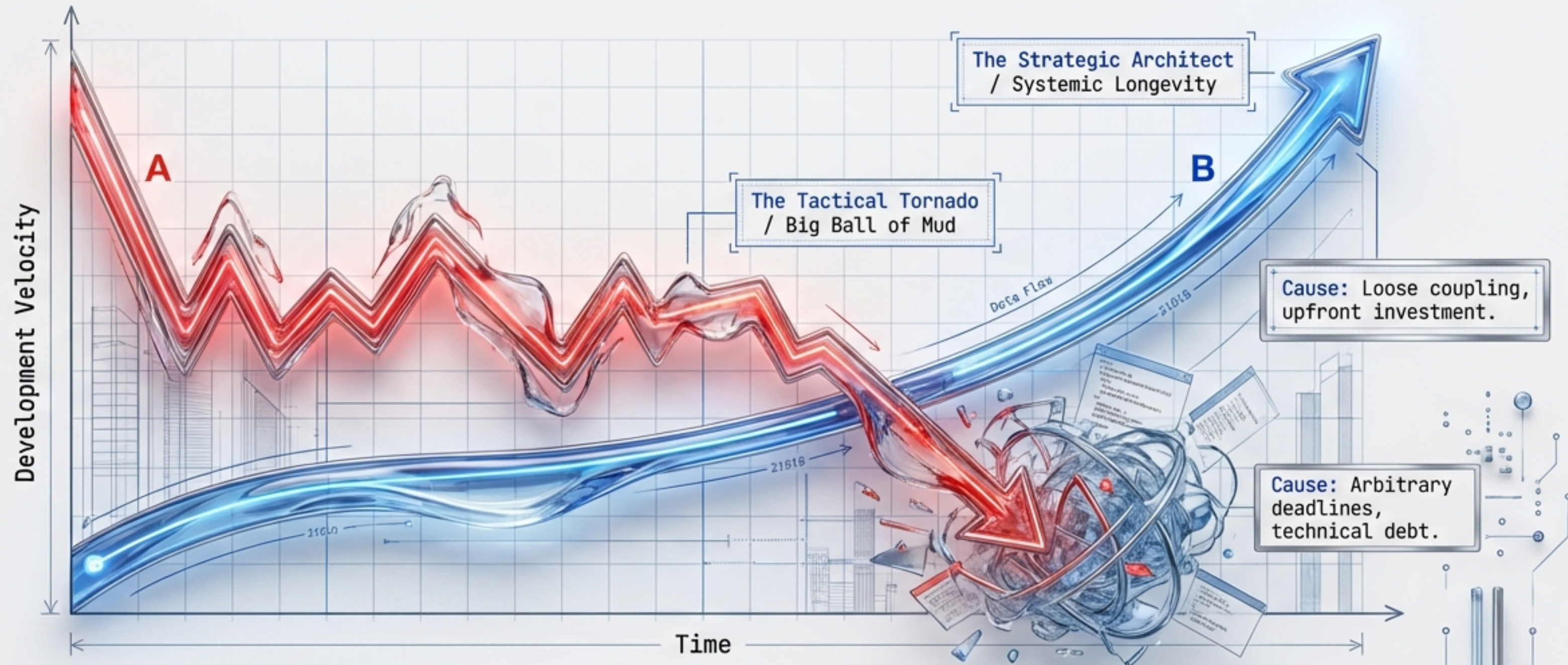

“Functional code is the baseline, not the goal.
System stability is the war.”

Organizational Topology: The Squad & Tribe Matrix

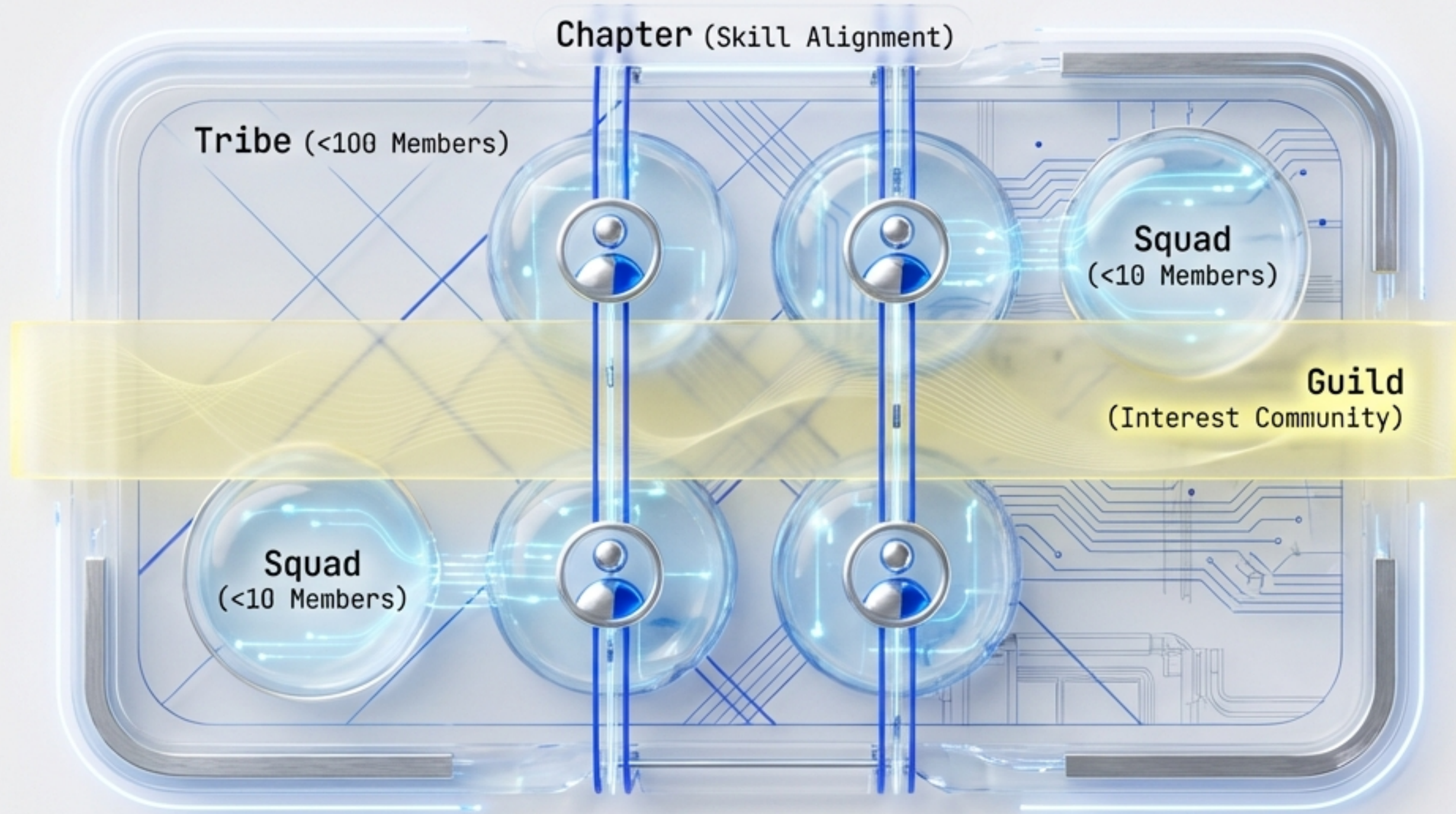

- **Squad:** Autonomous micro-startup. End-to-end responsibility.
- **Tribe:** Capped at Dunbar's Number to maintain trust.
- **Chapter:** Vertical specialist alignment.
- **Guild:** Horizontal community of interest.

Autonomy at the Squad level. Alignment at the Tribe level.

DevEx & Platform Engineering

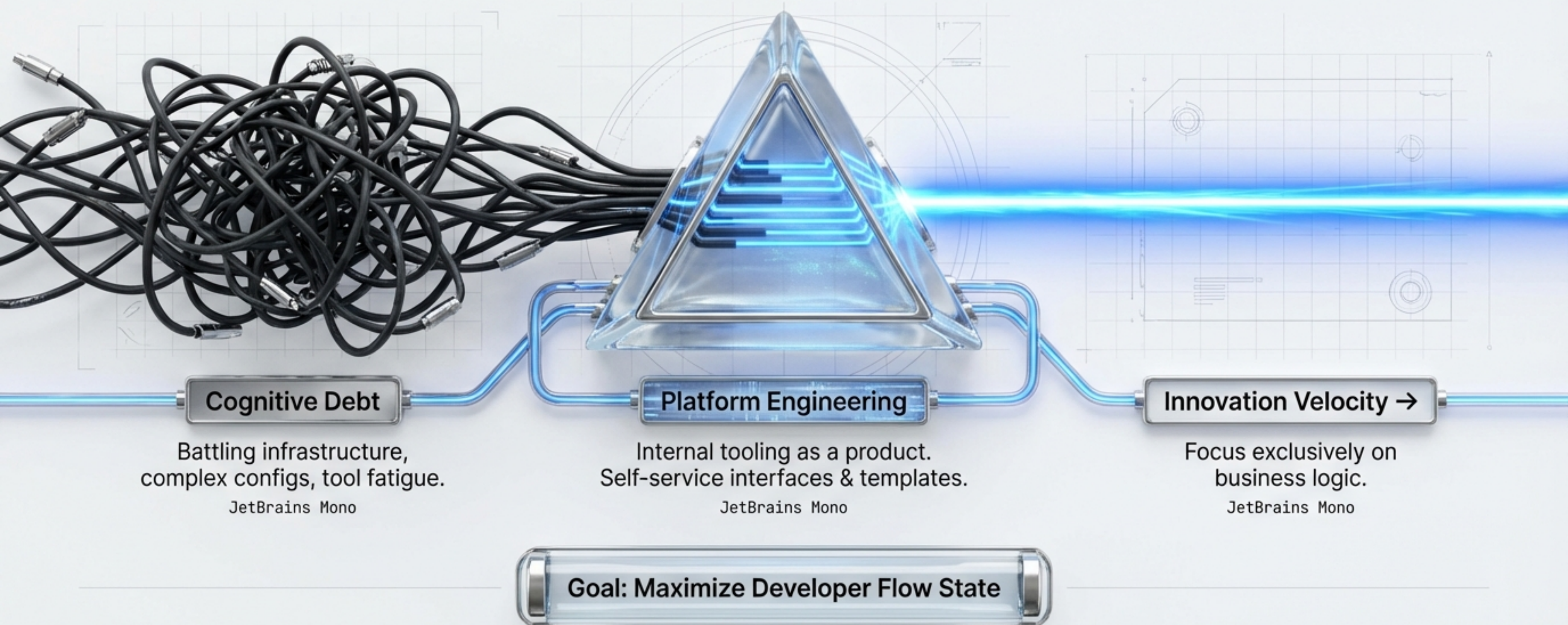

Quality Assurance: The Code Review Protocol

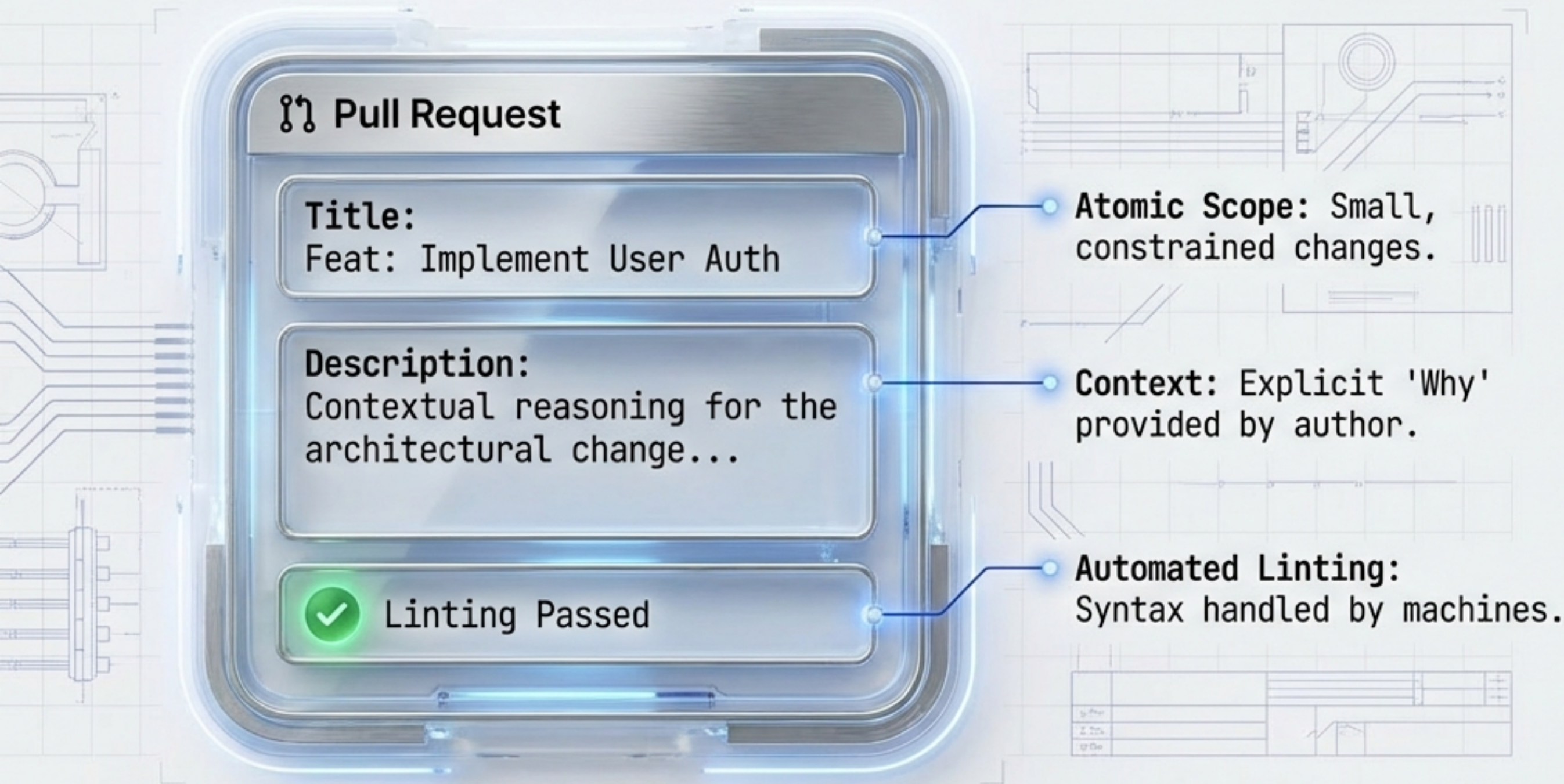

Cultural Rules:

- Feedback attacks the code, never the coder.
- Nit-picking is delegated to static analysis tools.
- **Goal:** Mentorship & Architecture.

Focus on logic and design, not syntax.

The CI/CD Architecture

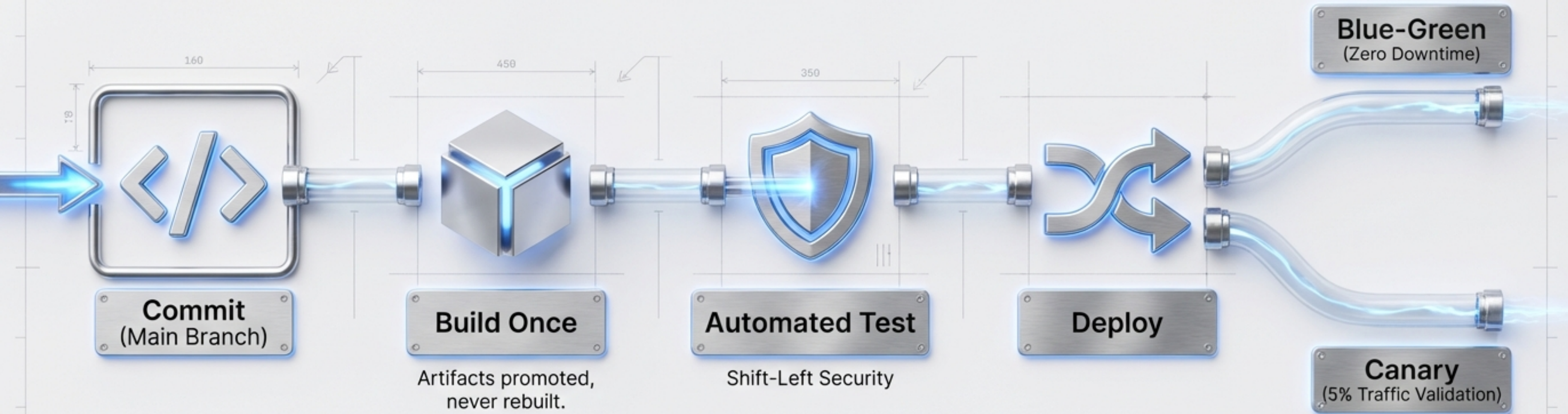

Imperative: Keep the build green. Rollback is the first response to failure.

MTTR (Mean Time To Recovery) | Deployment Frequency

Cyber-Resilience & Incident Response (IRP)

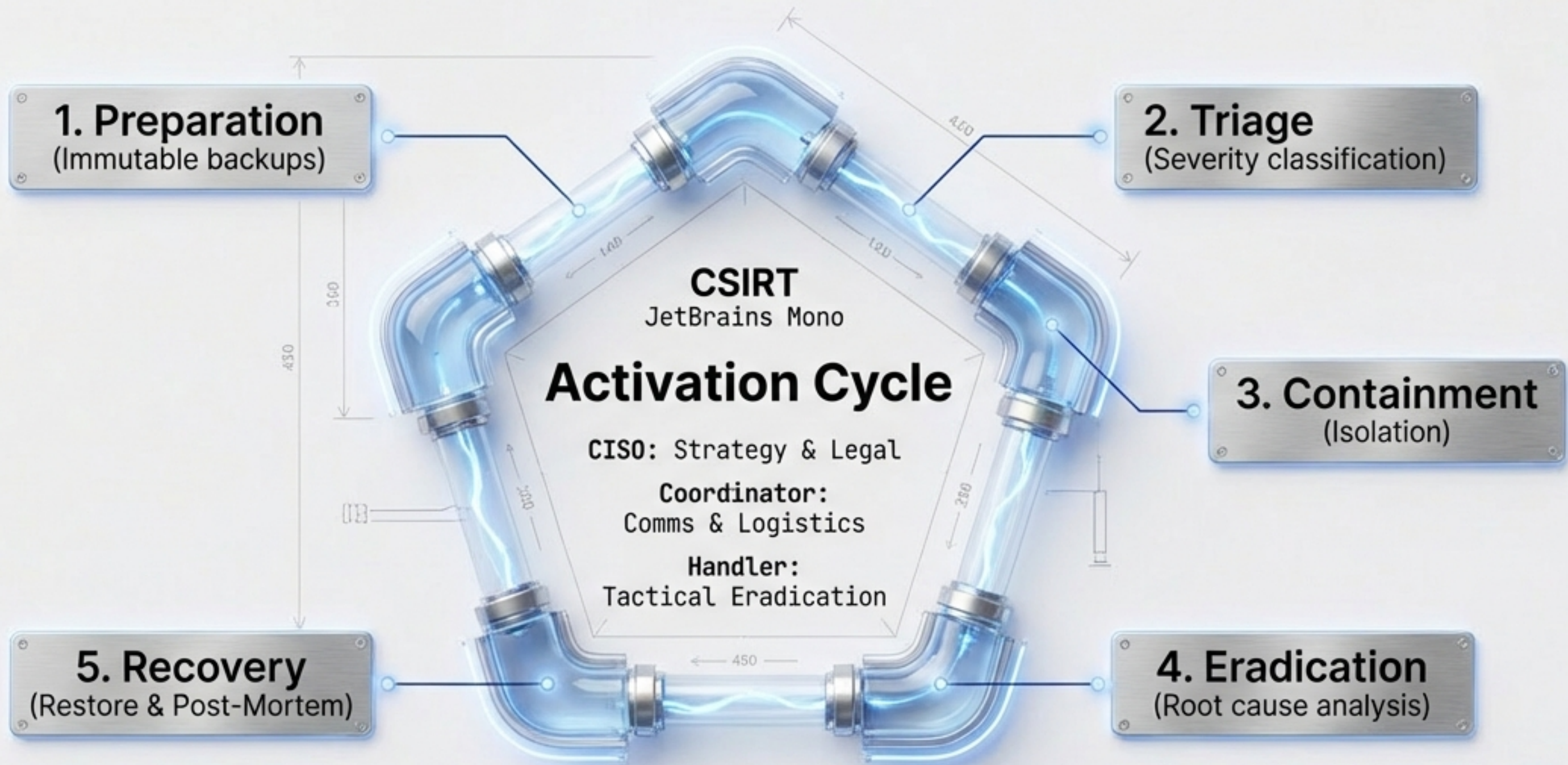

Blameless Post-Mortems are mandatory.

Data Privacy & The Legal Firewall



Side Note: Navigating the collision of Criminal Law and Civil Privacy.

The Fiscal Architecture



Operational
legitimacy
requires mastery
of the tiered
regulatory
framework.

The fiscal architecture defines the boundaries and opportunities of your operational legitimacy.

Human Capital & Labor Ethics

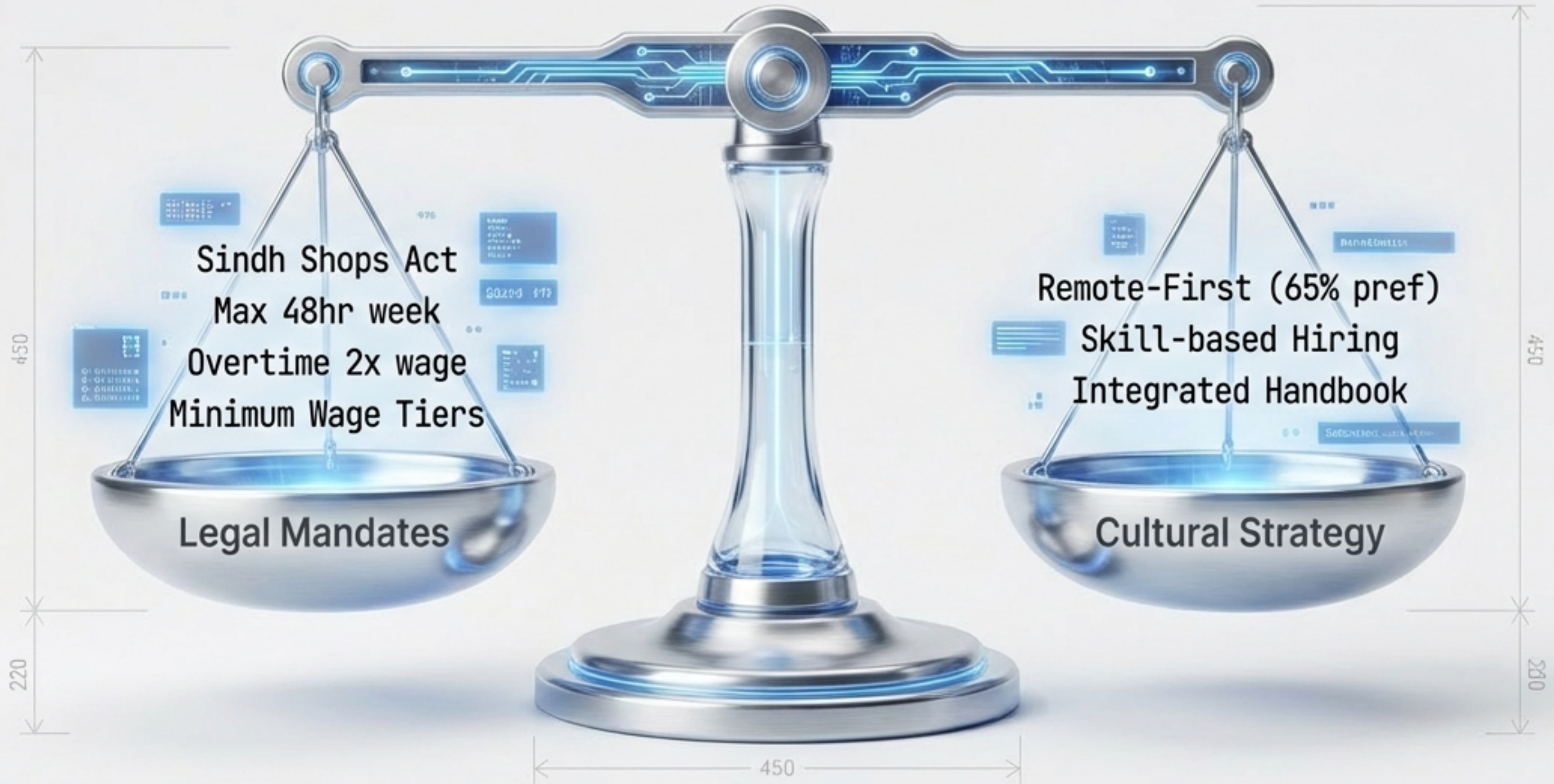

Compliance is the floor. Culture is the ceiling.

Knowledge Architecture: SOPs vs. Playbooks vs. Runbooks

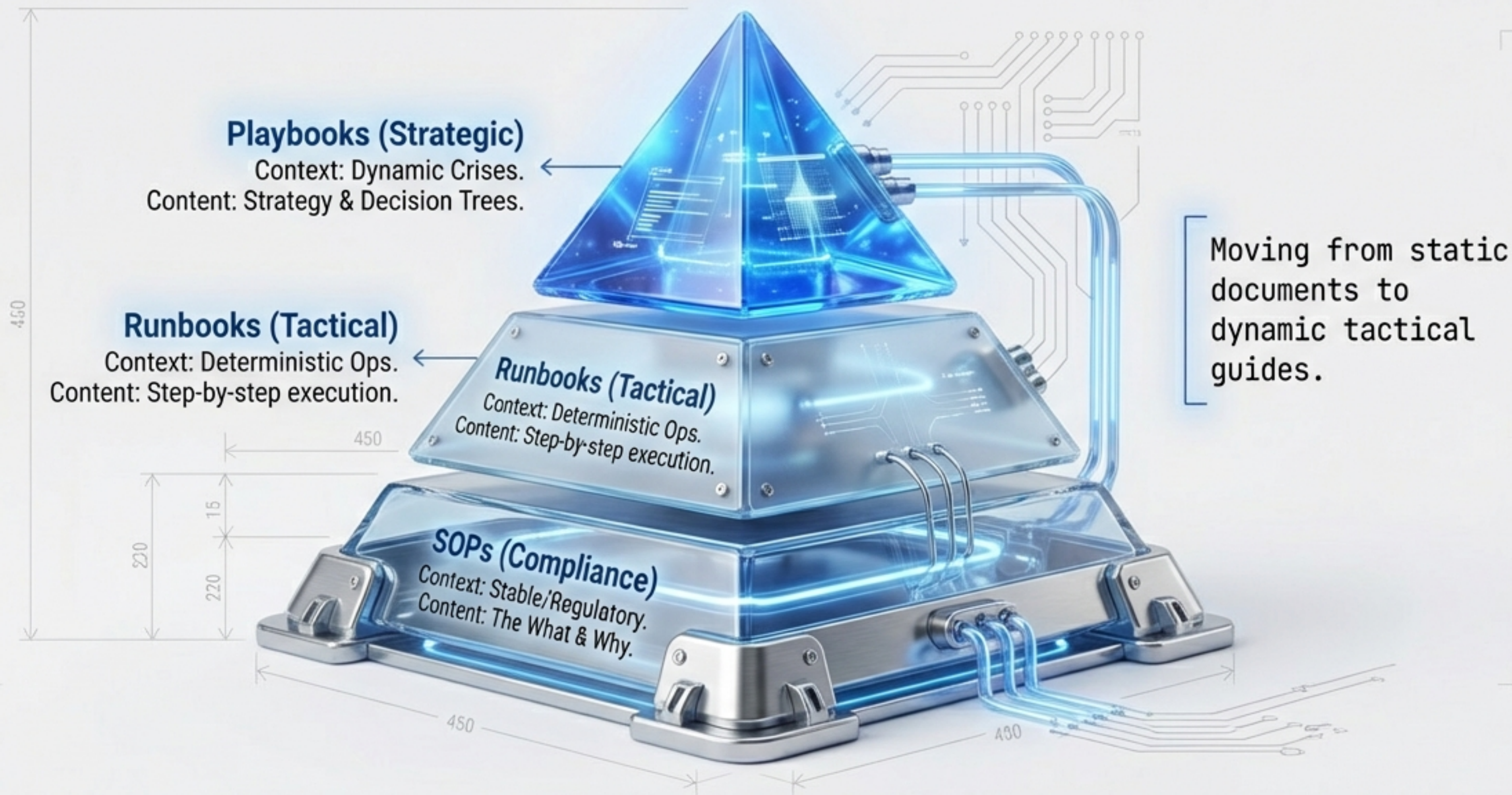

The Digital Ecosystem Manifesto

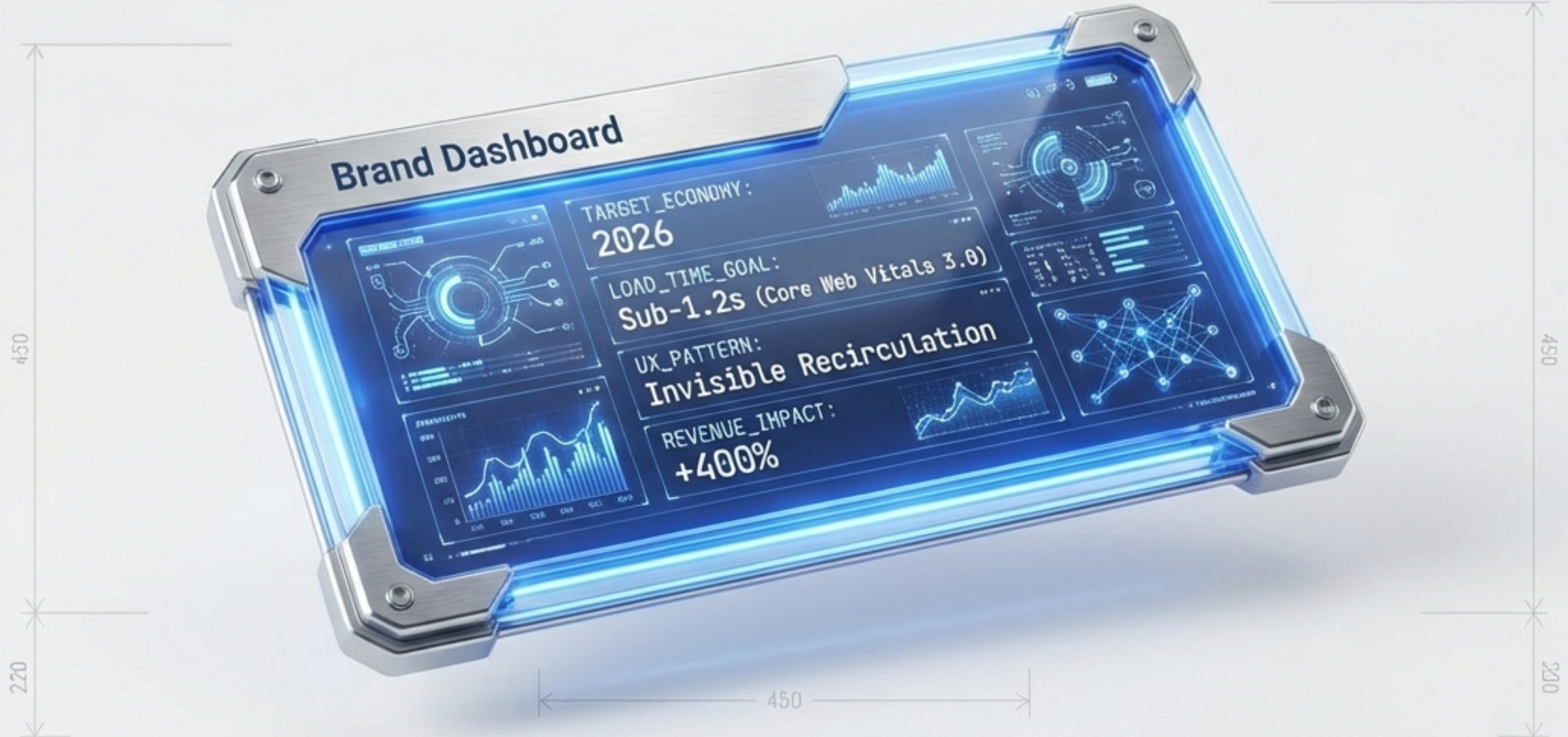

We are not just a vendor; we are an Immersed Business Partner.
We replace traditional layouts with high-fidelity brand manifestos.

2026–2030: The Ecosystem Decade

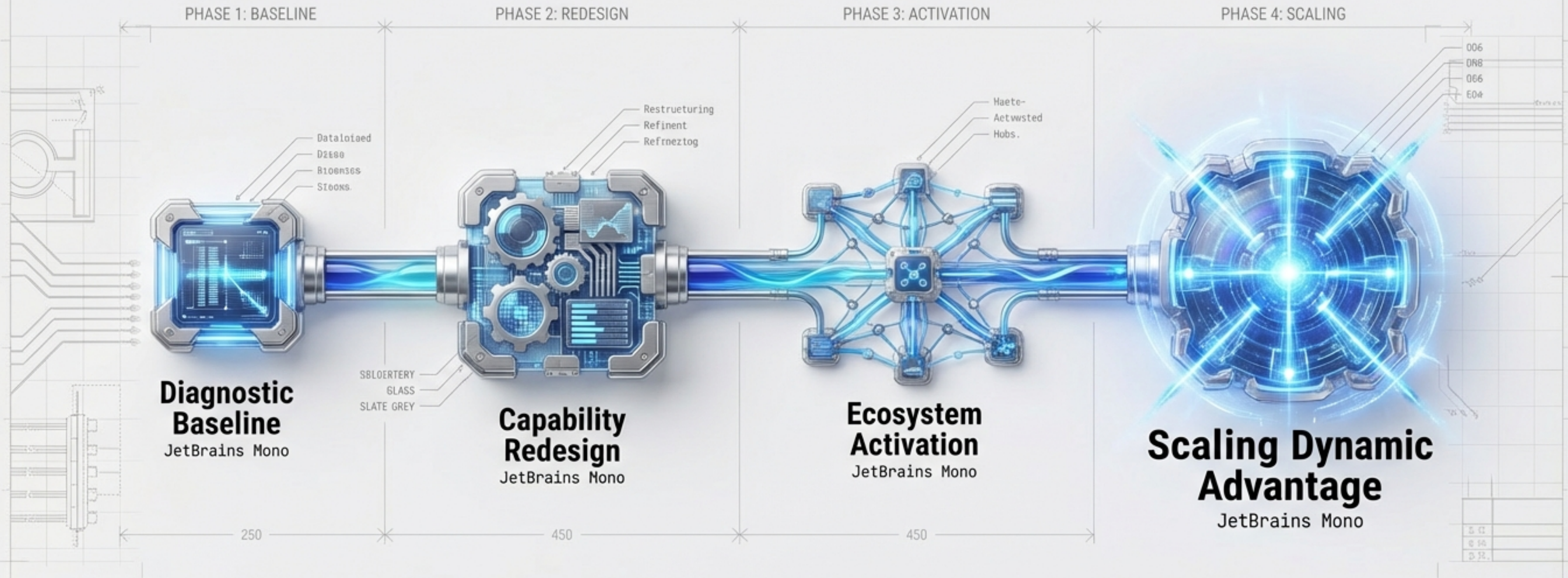

The winners will not be the largest firms, but the ecosystems that learn the fastest.